

# Mercmaster™ III 400 Luminaire for Hazardous and Wet Locations

## High Pressure Sodium and Pulse Start Metal Halide

Listed for simultaneous exposure to combustible dusts and flammable gases or vapors.

### NEC/CEC:

Class I, Division 2, Groups A, B, C, D  
Class I, Zone 2, AEx nA nR IIC (Z2)  
Class I, Zone 2, AEx/Ex nR IIC (ZB)  
Class II, Division 1 and 2, Groups E, F, G  
Class III

### NEC/CEC:

Simultaneous Exposure (Class I, Division 2/  
Class II, Division 1)  
Fixtures Outside Type (Salt Water)  
Type 4X  
IP66

## Applications

- Enclosed and gasketed fixtures suitable for use in:
  - Marine and wet locations
  - A wide range of industrial, chemical processing and other areas where flammable gases and vapors or combustible dusts are present under conditions defined by the National Electrical Code as Class I, Division 2; Class II, Division 1 and 2; and Class III
  - In applications involving medium and high mounting heights
  - In applications where energy efficient, high lumen output is required
  - The AEx nA nR Mercmaster III fixture is factory sealed and prevents vapors and gases from entering the globe chamber. There are no seals or putty required.
  - The AEx/Ex nR Mercmaster III fixture requires all wiring entries to be sealed.
  - Non-hazardous locations where severe weather conditions, excessive moisture, dirt, dust, corrosive atmosphere or high ambient temperatures are encountered
- Typical applications include:
  - Pulp and paper mills
  - Processing plants
  - Chemical plants
  - Oil refineries
  - Foundries
  - Manufacturing plants
  - Storage areas
  - Waste and sewage treatment
  - Other areas where dust, water, dirt and rough usage are a problem

## Features

- Superior corrosion resistance.
- Choice of light sources: high pressure sodium, and pulse start metal halide.
- Six mounting arrangements to suit any lighting layout: pendant, ceiling, wall bracket, 25° (angle) stanchion, 90° (straight) stanchion and cone.
- Hinge has high lip for added safety during installation and servicing. Hinge and bolt construction assures 360° compression at all points on ballast housing gasket for positive sealing. Swing away design of captive bolt and nut simplifies servicing.
- Choice of optical assemblies: prismatic globe; enclosed reflector with sealed lens; or Type V or Type II closed prismatic glass refractor, with or without guards.
- Wide choice of photometric distributions.
- All fixtures designed to perform in a +40 °C (+104 °F) ambient temperature. Selected fixtures are suitable for ambient temperatures up to +65 °C (+149 °F), for HPS up to -40 °C (-40 °F) and PSHM up to -30 °C (-22 °F).
- Mogul base porcelain lamp holder with nickel-plated contacts has +200 °C (+392 °F) rated welded leads, pre-wired to the ballast. Assures trouble-free operation in installations where high ambient temperatures are encountered.
- For electrical protection, a ground wire is provided on each Mercmaster to bond hood and ballast housing.
- Terminal blocks are provided for Zone 2 fixtures to facilitate wiring.
- Standard dome of 30° angle reflectors made of fiberglass reinforced white polyester. Highly resistant to corrosive atmospheres.
- A wide range of voltages available (120 to 600 Volt) and ballast types (CWA, Super CWA and REG LAG).
- One-piece ballast housing for each component provides even heat dissipation for cooler operation and longer ballast life.
- All Mercmaster mounting hoods have provision for easy field



Pendant with Prismatic Glass Globe



Pendant Cone with 12" Glass Refractor



Ceiling with Enclosed Reflector



Wall with 12" Glass Refractor



25° Stanchion with Prismatic Glass Globe and Guard



90° Stanchion with Prismatic Glass Globe and Guard

installation of fuses in fixtures (see fuse kit listings).

## Standard Materials

- Mounting hoods and ballast bodies: cast copperfree (less than 4/10 of 1% copper) aluminum
- Reflectors: Fiberglass reinforced white polyester
- Guards, hardware and catch assemblies: stainless steel
- Globe: heat- and impact-resistant internally fluted glass
- Refractors: prismatic glass
- Enclosed reflector: etched Alzak aluminum with sealed, tempered heat- and impact-resistant lens
- Body and globe gaskets: high-temperature silicone rubber

## Standard Finishes

- Mounting hoods and guards: epoxy powder coat, electrostatically applied for complete and uniform protection

## Options

- AEx nA nR fixtures are available with a Class I, Zone 2 rating. Add suffix **-Z2**. Only available for certain ballast types.
- AEx/Ex nR fixtures are available with a Class I, Zone 2 rating. Add suffix **-ZB**.
- Quartz Auxiliary comes to full brightness immediately and remains lit until the HID lamp attains 60-70% of full illumination. Quartz Auxiliary supplied with relay switch and socket to accept 120 V quartz double-contact bayonet base lamp (not included). (Not suitable for hazardous locations.) Add suffix **-E**.
- Factory sealed photocontrol available. See PCD2 Series.
- Smart Starter incorporates a 1-1/2-minute timer and performs as a conventional starter to normally start lamp. Removes itself from circuit if lamp burns out or is removed from socket. Eliminates starter failures caused by prolonged operation with cycling or failing lamps and simplifies finding their location, reducing maintenance and repair costs. Available for all HPS and PSMH fixtures. Add suffix **-S**.

# Mercmaster™ III 400 Luminaire for Hazardous and Wet Locations

## High Pressure Sodium and Pulse Start Metal Halide

Listed for simultaneous exposure to combustible dusts and flammable gases or vapors.

### NEC/CEC:

Class I, Division 2, Groups A, B, C, D  
Class I, Zone 2, AEx nA nR IIC (Z2)  
Class I, Zone 2, AEx/Ex nR IIC (ZB)  
Class II, Division 1 and 2, Groups E, F, G  
Class III

### NEC/CEC:

Simultaneous Exposure (Class I, Division 2)  
Class II, Division 1)  
Fixtures Outside Type (Salt Water)  
Type 4X  
IP66

### NEC/CEC Certifications and Compliances

- cULus Listed: E10444
- UL Standard: ANSI/UL 844, 1598, 60079-0, 60079-15, 1598A
- CSA Standard: CSA C22.2 No. 250.0, C22.2 No. 137; CAN/CSA E60079-0, E60079-15

- 250 W PSMH not available in MT ballast. See Mercmaster III, 50-250 Luminaires.

### Illustrated Features



#### High Temperature Sockets

Mogul base high-temperature porcelain sockets.

#### Aluminum Inner Reflector

Solid aluminum inner reflector (for refractor ballast housings only) improves photometric efficiency.

#### Globe Chamber

Completely sealed from the ballast housing and outside vapors/air (nR).



#### Vented Reflectors

Reflectors are thick, tough fiberglass-reinforced white polyester, vented for cooler operation. Quickly attach with furnished stainless steel screws.

#### Terminal Blocks (Zone 2)

A seven-point terminal block is provided to facilitate wiring. Terminal block accommodates wire size ranging from #8 to #24 AWG.

#### Stainless Steel Inserts

Ballast bodies have stainless steel threaded inserts to receive stainless steel screws for reflectors and guard. Prevents "freezing", allowing guards and reflectors to be easily removed and replaced at any time, without damage to the housing.

#### Epoxy Finish

Ballast housing, hoods and guards are copperfree aluminum with epoxy powder coat finish.

#### Photocell

Available for all fixtures except cone and ceiling mount. Installs through knock-out in mounting hood. Provides continuous ON-OFF dusk-to-dawn control.

#### Prismatic Glass Globes, Refractors and Enclosed Reflector

Heat-resistant globes, refractors and enclosed reflector thread into ballast housing and seal against a high temperature silicone rubber gasket.



#### Ballast Assembly

Utilizing non-sparking components avoiding the ignition of gases or vapors that may be present (nA).

#### Mounting Hood and Globe Gaskets

Silicone rubber gasket seals out moisture, dirt and dust. Stays flexible, withstands high temperatures. Closure design assures uniform gasket compression.

#### Electrical Protection

Ground wire provided to bond mounting hood to ballast housing.



#### "Safety" High Hinge

Extra-high hinge provides additional protection against accidental ballast housing disengagement during installation or maintenance.



#### Stainless Steel Latch Assembly

Captive, stainless steel latch assembly bolt and nut closes securely, resists attack of corrosive atmospheres. Swing-away design simplifies servicing.



#### Cooler Operating Cone Hood

Larger sloped surface sheds dusts, dirt and combustible fibers providing better heat dissipation.

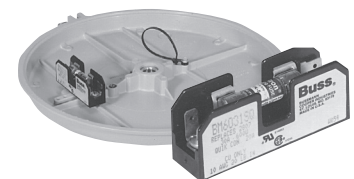

#### Fuses

Two screws secure fuse kit to mounting boss in any Mercmaster mounting hood. Fuse included.

# Mercmaster™ III 400 Luminaire for Hazardous and Wet Locations

## High Pressure Sodium and Pulse Start Metal Halide

Listed for simultaneous exposure to combustible dusts and flammable gases or vapors.

**NEC/CEC:**

Class I, Division 2, Groups A, B, C, D  
 Class I, Zone 2, AEx nA nR IIC (Z2)  
 Class I, Zone 2, AEx/Ex nR IIC (ZB)  
 Class II, Division 1 and 2, Groups E, F, G  
 Class III

**NEC/CEC:**

Simultaneous Exposure (Class I, Division 2/  
 Class II, Division 1)  
 Fixtures Outside Type (Salt Water)  
 Type 4X  
 IP66

### Mercmaster III 400 Family Tree

Pendant & Flexible  
 Pendant Mount ①



KPA & KPAF

Pendant Cone Mount



KPCH

Ceiling Mount



KPC

Wall Mount ①②



KPWB

25° Stanchion Mount ①



KPS

90° Stanchion Mount ①②



KPST

Ballast Housing

(250, 400 W HPS, 250 – 400 W PSMH)



KPB400

Globe



VPGL-4HR (Heat-Resistant Glass)

Guard (Optional Accessory)



KPGU400

White Polyester Reflector (Optional Accessory)



CMR-4ST (Standard)  
 CMR-4DD (Deep Dome) ④



CMR-4AN (30° Angle)

Enclosed Reflector Assembly



KPR-4HB (Glass Lens)

Guard (Optional Accessory)

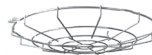

GHB7000-NG

Closed Prismatic Refractors



KPRF-400 (Heat-Resistant Glass) ③

Guard (Optional Accessory)



KPBG12

① Mounting hood with a 120 V or 208-277 V factory installed photocell is available.

② Standard and deep dome reflectors may interfere with bottom conduit entry if used with KPST and KPWB mounting hoods.

③ Available in NEMA Type II and V.

④ Fixtures when used with Deep Dome Refletors are NOT UL Listed.

# Mercmaster™ III 400 Luminaire for Hazardous and Wet Locations

## High Pressure Sodium and Pulse Start Metal Halide

Listed for simultaneous exposure to combustible dusts and flammable gases or vapors.

### NEC/CEC:

Class I, Division 2, Groups A, B, C, D  
 Class I, Zone 2, AEx nA nR IIC (Z2)  
 Class I, Zone 2, AEx/Ex nR IIC (ZB)  
 Class II, Division 1 and 2, Groups E, F, G  
 Class III

### NEC/CEC:

Simultaneous Exposure (Class I, Division 2/  
 Class II, Division 1)  
 Fixtures Outside Type (Salt Water)  
 Type 4X  
 IP66

Order using catalog numbering guide below or select catalog number from tables on following pages.

### Catalog Numbering Guide

<p><b>KP</b></p> <p>Series:                  KP - Mercmaster                  III 400</p>	<p><b>A</b></p> <p>Mounting:                  A - Pendant (rigid mounting)                  C - Ceiling                  CH - Pendant Cone Hood                  F - Pendant (flexible mounting)                  ST - 90° Stanchion                  S - 25° Stanchion                  WB - Wall</p>	<p><b>L</b></p> <p>Lamp Type:                  L - High Pressure Sodium                  P - Pulse Start Metal Halide</p>	<p><b>40</b></p> <p>Wattage:                  25 - 250 W HPS, PSMH ⑤                  40 - 400 W PSMH &amp; HPS</p>	<p><b>10</b></p> <p>Hub Size:                  75 - 3/4" NPT                  10 - 1" NPT                  125 - 1-1/4" NPT stanchion                  150 - 1-1/2" NPT stanchion</p>	<p><b>J5</b></p> <p>Optical Assembly: ①                  Blank - Glass Globe                  J2 - NEMA II Glass Refractor ④                  J5 - NEMA V Glass Refractor ④                  R - Enclosed Refractor with Sealed Lens ⑦</p>	<p><b>G</b></p> <p>Guard Options: ②                  G - Globe Guard                  BG - Refractor Guard                  Blank - No Guard</p>	<p><b>MT</b></p> <p>Voltage: ③                  MT - 120/208/240/277, 60 Hz                  5MT - 120/208/240/277/480, 60 Hz                  TT - 120/277/347, 60 Hz                  48 - 480, 60 Hz                  AM - 127/220, 60 Hz                  125 - 120, 50Hz                  226 - 220, 60 Hz                  235 - 230, 50Hz                  236 - 230, 60 Hz                  245 - 240, 50 Hz                  246 - 240, 60 Hz                  385 - 380/415, 50 Hz</p>	<p><b>S</b></p> <p>Options:                  E - Emergency Quartz                  F - Fuse Kit (Specify Voltage)                  S - Smart Starter                  H1 - Photocontrol 120 V                  H2 - Photocontrol 208 V                  H3 - Photocontrol 240 V                  H4 - Photocontrol 277 V                  E40 - Export Socket</p> <p>Optional Fusing ⑥                  FN - 120 V                  FP - 208 V                  FS - 240 V                  FT - 277 V                  FF - 480 V</p>	<p><b>Z2</b></p> <p>Suffix:                  Z2 - Zone 2 suffix (required for AEx nA nR rating) ⑧                  ZB - Zone 2 suffix (required for AEx/Ex nR rating)</p>
---	--	---	---	---	--	--	--	--	---

### Voltages

Lamp Type	Lamp Watts	Voltage Suffixes											
		MT	5MT	TT	48	AM	125	226	235	236	245	246	385
HPS	250	X	X	—	X	X	X	X	X	X	X	X	X
HPS	400	X	X	X	X	X	X	—	X	X	—	X	—
PSMH	250	—	X	X	X	—	X	X	X	—	—	X	—
PSMH	400	X	X	X	X	—	—	—	X	—	—	X	—

### Voltages:

<b>MT</b> - 120/208/240/277 V, 60 Hz	<b>48</b> - 480 V, 60 Hz	<b>226</b> - 220 V, 60 Hz	<b>245</b> - 240 V, 50 Hz
<b>5MT</b> - 120/208/240/277/480 V, 60 Hz	<b>AM</b> - 127/220 V, 60 Hz	<b>235</b> - 230 V, 50 Hz	<b>246</b> - 240 V, 60 Hz
<b>TT</b> - 120/277/347 V, 60 Hz	<b>125</b> - 120 V, 50 Hz	<b>236</b> - 230 V, 60 Hz	<b>385</b> - 380/415 V, 50 Hz

Refer to "Mounting Hoods and Ballast" page for available Voltage Configuration.

- ① NO DESIGNATION is required for fixtures with standard type globe.
- ② NO DESIGNATION is required for fixtures without guards.
- ③ Other voltages available. Contact your local sales representative.
- ④ J2 and J5 refractors are not available with Z2 or ZB suffix.
- ⑤ Available for 480 V, 50 Hz and 5MT ballast options. For MT and TT voltage suffix, see Mercmaster III 50-250 Luminaires.
- ⑥ Optional fusing is available for use with MT, 5MT and 48 voltage suffixes ONLY.
- ⑦ Not certified for use with Class I, Zone 2 rated fixtures.
- ⑧ The -Z2 suffix (AEx nA nR) is available for use with MT, 5MT, 48 and 246 voltage suffixes ONLY.

# Mercmaster™ III 400 Luminaire for Hazardous and Wet Locations

Class I, Division 2; Class II, Division 1; Simultaneous Exposure to Hazardous Conditions on Both Classifications

Temperature identification numbers of Mercmaster III – 400 Fixtures.

**NEC/CEC:**

Class I, Division 2, Groups A, B, C, D  
 Class I, Zone 2, AEx nA nR IIC (Z2)  
 Class I, Zone 2, AEx/Ex nR IIC (ZB)  
 Class II, Division 1 and 2, Groups E, F, G  
 Class III

**NEC/CEC:**

Simultaneous Exposure (Class I, Division 2/  
 Class II, Division 1)  
 Fixtures Outside Type (Salt Water)  
 Type 4X  
 IP66

**“T” Numbers**

Lamp Watts	Supply Wire Temp. °C Type	Ambient Temp. °C (°F) ①	Class I, Division 2				Class II, Division 1 Groups E, F and G				Simultaneous Exposure Class I, Division 2 / Class II, Division 1				
			Globe	Reflector	Refractor	Enclosed Reflector	Globe	Reflector	Refractor	Enclosed Reflector	Globe	Reflector	Refractor	Enclosed Reflector	
	125 °C (257 °F)	40 °C (104 °F)	T2	T2	T2	T2	T3B	T3B	T4	T4A	325	325	325	325	
250	HPS	125 °C (257 °F)	55 °C (131 °F)	325	325	T2	T2	—	—	T3B	T4A	—	—	T1	325
	125 °C (257 °F)	65 °C (149 °F)	—	—	T2	T2	—	—	T3B	T4	—	—	T1	350	
400	HPS	90 °C (194 °F)	40 °C (104 °F)	350	T1	T1	350	T3 ②	T3 ②	T3C	T3C	T1	T1	T1	350
	90 °C (194 °F)	40 °C (104 °F)	T2A	T2A	T2B	T2C	T3 (EF)	T3 (EF)	T4	T4A	—	—	—	—	
250	PSMH	90 °C (194 °F)	55 °C (131 °F)	T2A	T2A	T2B	T2C	—	—	—	—	—	—	—	
	90 °C (194 °F)	65 °C (149 °F)	—	—	—	T2C	—	—	—	—	—	—	—	—	
400	PSMH	90 °C (194 °F)	40 °C (104 °F)	T2A	T2A	T2B	T2B	—	—	T3C	T3C	—	—	—	—

**“T” Numbers Represent the Maximum Lamp Temperature for Class I, Division 2 Locations and Maximum Surface Temperature Under Dust Blanket for Class II, Division 1 Locations**

“T” Number	T1	350	325	T2	T2A	T2B	T2C	T2D	T3	T3A	T3B	T3C	T4	T4A	T5	T6
Temp Range (°C)	351- 450	326- 350	301- 325	281- 300	261- 280	231- 260	216- 230	201- 215	181- 200	166- 180	161- 165	136- 160	121- 135	101- 120	86- 100	85
Temp. Range (°F)	664- 842	619- 662	574- 617	538- 572	502- 536	448- 500	421- 446	394- 419	358- 392	331- 356	322- 329	277- 320	250- 275	214- 248	187- 212	185

① Use +90 °C (+194 °F) rated supply wire.  
 ② “T” numbers are for Groups E and F only.

# Mercmaster™ III 400 Luminaire for Hazardous and Wet Locations

Class I, Zone 2, AEx/Ex nR IIC, AEx nA nR IIC, IP66, NEMA 4X

Temperature identification numbers of Mercmaster III – 400 Fixtures.

**NEC/CEC:**

Class I, Division 2, Groups A, B, C, D  
 Class I, Zone 2, AEx nA nR IIC (Z2)  
 Class I, Zone 2, AEx/Ex nR IIC (ZB)  
 Class II, Division 1 and 2, Groups E, F, G  
 Class III

**NEC/CEC:**

Simultaneous Exposure (Class I, Division 2/  
 Class II, Division 1)  
 Fixtures Outside Type (Salt Water)  
 Type 4X  
 IP66

**“T” Numbers**

Watts	Lamp Type	Supply Wire Temp. °C (°F) ①	Ambient Temp. °C (°F) ①	Class 1, Zone 2 AEx nA nR		Class 1, Zone 2 AEx/Ex nR	
				Globe	Globe & Reflector	Globe	Globe & Reflector
250	HPS	110 (230)	40 (104)	T3	T3	T3	T3
	HPS	110 (230)	55 (131)	T3	T3	T3	T3
400	HPS	90 (194)	40 (104)	T3	T3	T3	T3
250	PSMH	90 (194)	40 (104)	T3	T3	T3	T3
	PSMH	90 (194)	55 (131)	T3	T3	T3	T3
400	PSMH	75 (167)	40 (104)	T3	T3	T3	T3

**“T” Numbers represent the maximum surface temperature for luminaires with AEx nA nR and AEx/Ex nR rating:**

To comply with AEx nR Requirements, all wiring entries must be sealed.

“T” Number	T1	T2	T3	T4	T5	T6
Temp. Range (°C)	301-450	201-300	136-200	101-135	86-100	85
Temp. Range (°F)	547-842	394-572	277-392	214-275	187-212	185

① Use +90 °C (+194 °F) rated supply wire.

APPLETON™

HID/AREA: NEC/CEC ENCLOSED AND GASKETED

# Mercmaster™ III 400 Luminaire for Hazardous and Wet Locations







## High Pressure Sodium and Pulse Start Metal Halide - Hazardous and Wet Locations

Listed for simultaneous exposure to combustible dusts and flammable gases or vapors.

**NEC/CEC:**  
 Class I, Division 2, Groups A, B, C, D  
 Class I, Zone 2, AEx nA nR IIC (Z2)  
 Class I, Zone 2, AEx/Ex nR IIC (ZB)  
 Class II, Division 1 and 2, Groups E, F, G  
 Class III

**NEC/CEC:**  
 Simultaneous Exposure (Class I, Division 2/  
 Class II, Division 1)  
 Fixtures Outside Type (Salt Water)  
 Type 4X  
 IP66

### Mounting Hoods

	Description	Hub Size (Inches)	Catalog Number
<b>Pendant</b>		One Hub, Rigid Mounting	KPA-75
			KPA-100
<b>Pendant – Flexible</b>		One Hub, Flexible Mounting	KPAF-75
			KPAF-100
<b>Pendant Cone</b>		One Hub, Rigid	KPCH-75
			KPCH-100
<b>Ceiling</b>		Five Hubs, Four Close-Up Plugs	KPC-75
			KPC-100
<b>Wall</b>		Five Hubs, Four Close-Up Plugs	KPWB-75
			KPWB-100
<b>25° Stanchion</b>		One Hub	KPS-125
			KPS-150
<b>90° Stanchion</b>		One Hub	KPST-125
			KPST-150

### Ballast Bodies



**High Pressure Sodium** – Constant Wattage (Min. P.F. 90%)  
**Pulse Start Metal Halide** – Constant Wattage (Min. P.F. 90%)

Lamp Type	Lamp Watts	Catalog Numbers	Voltage Suffixes											
			MT	5MT	TT	48	AM	125	226	235	236	245	246	385
HPS	250	KPB250L ①②③	X	X	—	X	X	X	X	X	X	X	X	X
HPS	400	KPB400L ①②③	X	X	X	X	X	X	—	X	X	—	X	—
PSMH	250	KPB250P ①②③④	—	X	X	X	—	X	—	X	—	—	X	—
PSMH	400	KPB400P ①②③	X	X	X	X	—	—	—	X	—	—	X	—

Voltages:

<b>MT</b> - 120/208/240/277 V 60 Hz	<b>48</b> - 480 V 60 Hz	<b>125</b> - 120 V 50 Hz
<b>5MT</b> - 120/208/240/277/480 V 60 Hz	<b>AM</b> - 127/220 V, 60 Hz	<b>226</b> - 220 V 60 Hz
<b>TT</b> - 120/277/347 V, 60 Hz	<b>235</b> - 230 V 50 Hz	<b>236</b> - 230 V 60 Hz
		<b>245</b> - 240 V 50 Hz
		<b>385</b> - 380/415 V, 50 Hz

- ① Add **-S** after voltage designation for ballast body with Smart Starter (HPS and PSMH only).
- ② Add **-E** after voltage designation for ballast body with provision for Quartz Emergency Light (not suitable for hazardous location).
- ③ Add **-Z2** suffix for factory sealed non-sparking/restricted breathing protection (AEx nA nR). The **-Z2** suffix (AEx nA nR) is available for use with MT, 48 and 246 voltage suffixes ONLY. Add **-ZB** suffix for restricted breathing protection (AEx/Ex nR).
- ④ Not available in MT. See Mercmaster III 50-250 Luminaires.

# Mercmaster™ III 400 Luminaire for Hazardous and Wet Locations

## High Pressure Sodium and Pulse Start Metal Halide - Hazardous and Wet Locations

Listed for simultaneous exposure to combustible dusts and flammable gases or vapors.

**NEC/CEC:**

Class I, Division 2, Groups A, B, C, D  
 Class I, Zone 2, AEx nA nR IIC (Z2)  
 Class I, Zone 2, AEx/Ex nR IIC (ZB)  
 Class II, Division 1 and 2, Groups E, F, G  
 Class III

**NEC/CEC:**

Simultaneous Exposure (Class I, Division 2/  
 Class II, Division 1)  
 Fixtures Outside Type (Salt Water)  
 Type 4X  
 IP66

Description	Catalog Number
-------------	----------------

**Prismatic Glass Globes — Heat-Resistant**



**Glass Globe**

Clear

**VPGL-4HR**

**Enclosed Reflector Assembly**



**Enclosed Reflector**

Heat- and impact-resistant glass lens

**KPR-4HB**

Light Distribution	IES/NEMA Distribution Curves	Catalog Number
--------------------	------------------------------	----------------

**Closed Prismatic Glass Refractors ② — All Heat-Resistant**



**Glass Refractor**

NEMA Type II



**KPRF400-2**

NEMA Type V



**KPRF400-5**

Item	Description	Catalog Number
------	-------------	----------------

**White Polyester Reflectors**



**Standard and Deep Dome**



**30° Angle**

For use with globe fixtures

Standard Dome

**CMR-4ST ①**

30° Angle

**CMR-4AN**

Deep Dome

**CMR-4DD ①③**

**Guards**



**Globe Guard**



**Refractor Guard**

Globe Guard

**KPGU400**

Refractor Guard

**KPBG12**

Enclosed Refractor Guard

**G-HB7000-NG**

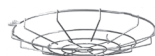

**Enclosed Refractor Guard**

① Contact your local sales representative if used with **KPWB** or **KPST** mounting hoods.

② Not suitable for use with **Z2** or **ZB** suffixes (Zone 2).

③ Fixtures when used with **Deep Dome** Refletors are **NOT UL Listed**.

# Mercmaster™ III 400 Luminaire for Hazardous and Wet Locations

## High Pressure Sodium and Pulse Start Metal Halide - Hazardous and Wet Locations

Listed for simultaneous exposure to combustible dusts and flammable gases or vapors.

**NEC/CEC:**  
 Class I, Division 2, Groups A, B, C, D  
 Class I, Zone 2, AEx nA nR IIC (Z2)  
 Class I, Zone 2, AEx/Ex nR IIC (ZB)  
 Class II, Division 1 and 2, Groups E, F, G  
 Class III

**NEC/CEC:**  
 Simultaneous Exposure (Class I, Division 2/  
 Class II, Division 1)  
 Fixtures Outside Type (Salt Water)  
 Type 4X  
 IP66

### Electrical Specifications

Line	Voltage	Frequency	Starting Amps	Operating Amps	Total Watts
<b>250 Watt High Pressure Sodium</b>					
120	60		2.00	2.50	295
208	60		1.20	1.50	295
240	60		1.00	1.30	295
277	60		0.85	1.10	295
480	60		0.40	0.65	295
120	50		1.85	2.75	300
230	50		0.95	1.44	300
<b>400 Watt High Pressure Sodium</b>					
120	60		3.30	3.80	465
208	60		1.80	2.20	465
240	60		1.60	1.90	465
277	60		1.40	1.70	465
480	60		0.80	1.00	465
120	50		3.70	4.00	465
230	50		1.85	2.00	465
<b>250 Watt Pulse Start Metal Halide</b>					
120	60		2.00	2.30	278
208	60		1.10	1.40	278
240	60		1.00	1.20	278
277	60		0.80	1.00	278
480	60		0.30	0.60	278
480	60		0.45	0.60	285
120	50		1.90	2.60	288
230	50		1.00	1.35	288
<b>400 Watt Pulse Start Metal Halide</b>					
120	60		3.10	3.70	447
208	60		1.70	2.10	447
240	60		1.50	1.90	447
277	60		1.30	1.60	447
480	60		0.80	0.95	446
120	50		3.17	3.90	454
230	50		1.65	2.00	454

### Fuse Kit

Order fuses as a separate item by catalog number from right columns.

Lamp Watts	Volts	Fuse Quantity Required	Fuse Catalog Number	
			HPS	PSMH
250	120	1	F7	F10
	208	2	F4	F6
	240	2	F4	F6
	277	1	F3	F5
	480	2	F2	F3
	120	1	F7	—
	230	2	F4	—
	250	480	2	—
400	230	1	—	F3
	120	1	F15	F12
	208	2	F8	F6
	240	2	F8	F6
	277	1	F5	F5
	480	2	F5	F3
	120	1	F10	F10
	230	2	F6	F5

APPLETON™

HID/AREA: NEC/CEC ENCLOSED AND GASKETED

# Mercmaster™ III 400 Luminaire for Hazardous and Wet Locations

## High Pressure Sodium and Pulse Start Metal Halide - Hazardous and Wet Locations

Listed for simultaneous exposure to combustible dusts and flammable gases or vapors.

**NEC/CEC:**

Class I, Division 2, Groups A, B, C, D  
 Class I, Zone 2, AEx nA nR IIC (Z2)  
 Class I, Zone 2, AEx/Ex nR IIC (ZB)  
 Class II, Division 1 and 2, Groups E, F, G  
 Class III

**NEC/CEC:**

Simultaneous Exposure (Class I, Division 2/  
 Class II, Division 1)  
 Fixtures Outside Type (Salt Water)  
 Type 4X  
 IP66

**Dimensions in Millimeters (Inches)**

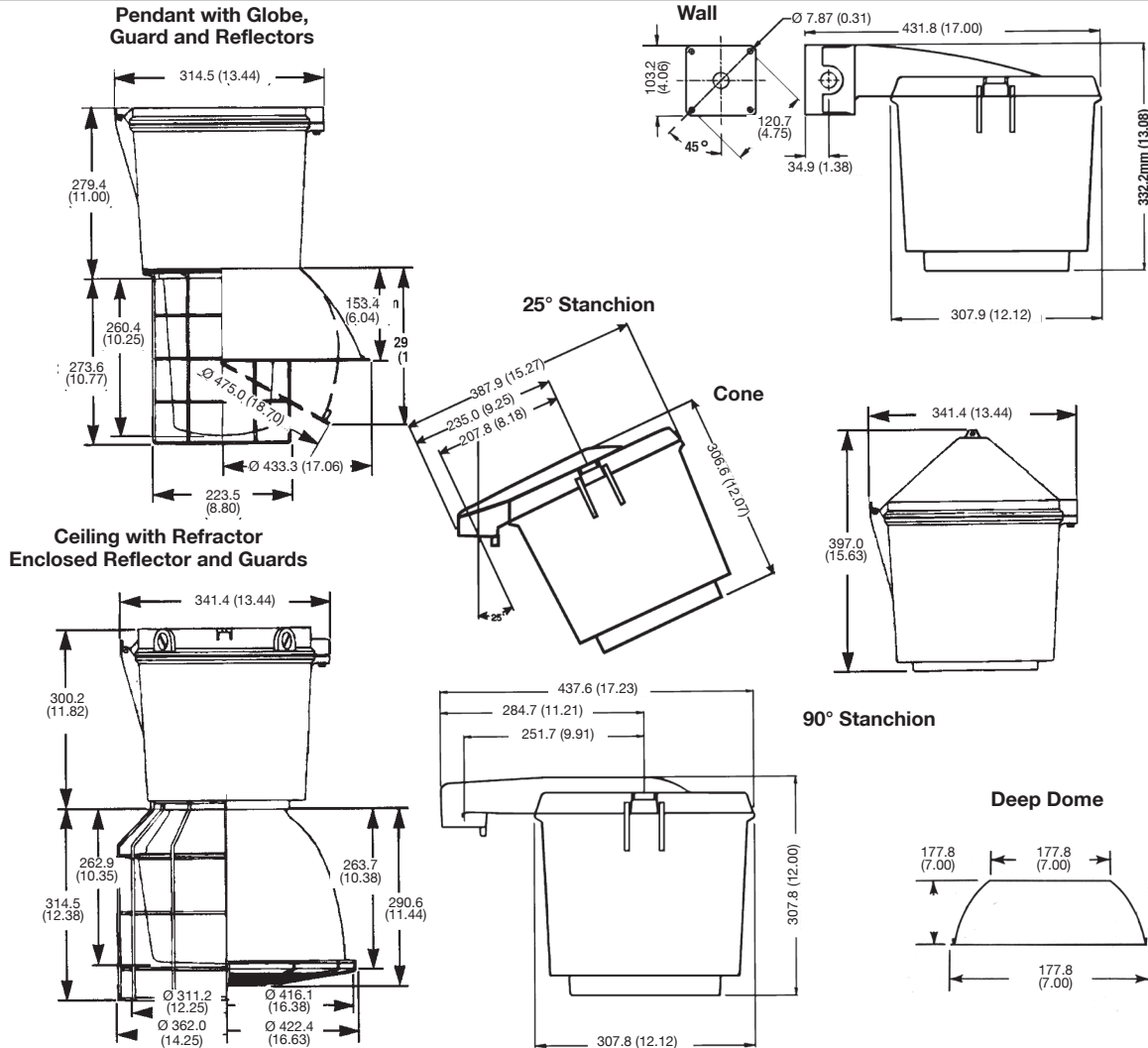

**Mercmaster III – 400 Ballast and Accessory Weights**

Lamp Watts	Ballast Housing Wt. kg (lb)		Mounting Hoods and Reflectors	Wt. kg (lb)	Globe Refractor, Enclosed Reflector and Guards	
	HPS	PSMH			Reflector and Guards	Wt. kg (lb)
250	11.1 (24.5)	—	Pendant	1.0 (2.25)	Glass Globe	3.2 (7.0)
			Pendant Cone	1.1 (2.50)	Globe Guard	1.4 (3.0)
			Ceiling	1.4 (3.00)	12" Glass Refractor	5.4 (12.0)
			Wall	1.8 (4.00)	Refractor Guard	2.0 (4.5)
400	12.9 (28.5)	12.9 (28.5)	25° Stanchion	1.5 (3.25)	Enclosed Reflector	5.0 (11.0)
			90° Stanchion	1.7 (3.75)	Enclosed Reflector Guard	0.9 (2.0)
			Standard Dome	1.6 (3.50)		
			30° Angle	1.6 (3.50)		

Weights are approximate. Add 0.11 kg (0.25 lb). for Quartz option.

# PCD2 Series Factory Sealed Hazardous Location Photocontrol

For use in Class I, Division 2, Groups A, B, C, D locations

Maintains Class I, Division 2 rating for Mercmaster III – Low Profile, Mercmaster III, and Mercmaster III – 400 Series Luminaires, Mercmaster LED

NEC/CEC:  
Class I, Division 2, Groups A, B, C, D  
NEMA 4X

## Applications

- Encapsulated photocontrol provides automatic dusk-to-dawn lighting control in Class I, Division 2 locations.
- Typical applications include walkways, security areas and any other outdoor lighting application.
- For use with Mercmaster III – Low Profile, Mercmaster III, and Mercmaster III – 400 Series Luminaires.
- For remote mounting in FS Boxes.

- 50-400 W HID, incandescent or fluorescent, 50/60 Hz.
- 1000 V.A. Voltage/Ampere
- Minimum time delay: 15 seconds to eliminate nuisance tripping.
- Provided with (3) 18AWG stranded leads 152.4 mm (6 in) in length.
- Will fit through standard 1/2" knockout.
- Supplied with locknut and gasket.

## Features



- Factory sealed design eliminates the need for an explosionproof enclosure.
- Can be easily installed in the field.
- Solid state design for performance and reliability.
- Available for 120, 208, 240, or 277 volts.

## Materials

- Encapsulated with epoxy sealing compound
- FS: aluminum

## NEC/CEC Certifications and Compliances

- UL Standard: 1604 – Hazardous (Classified) Locations
- cULus Recognized

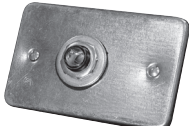
	Voltage Range	Max VA	Max Current Amps	Suffix Designation Catalog Number
<b>Factory-Installed Photocontrol - Not for ceiling or pendant cone.</b> <i>Add to fixture catalog after voltage; i.e.: KPWBL1075MTH1.</i>				
	120 V, 50/60 Hz	1000	—	H1
	208 V, 50/60 Hz	1000	—	H2
	240 V, 50/60 Hz	1000	—	H3
	277 V, 50/60 Hz	1000	—	H4
<b>Photocontrol for Field Installation</b>				
	120 V, 50/60 Hz	1000	8.3 Amp	PC120D2
	208 V, 50/60 Hz	1000	4.8 Amp	PC247D2
	240 V, 50/60 Hz	1000	4.2 Amp	
	277 V, 50/60 Hz	1000	3.6 Amp	
<b>Photocontrol in FS Cover for Use with FS/FD Box</b> <i>Photocontrol assembly supplied with two stainless steel screws and one neoprene gasket.</i> <i>For additional neoprene gaskets, order catalog numbers FS-GKR-1N.</i>				
	120 V, 50/60 Hz	1000	8.3 Amp	FSKA-PC120D2
	208, 50/60 Hz	1000	4.8 Amp	FSKA-PC247D2
	240 V, 50/60 Hz	1000	4.2 Amp	
	277 V, 50/60 Hz	1000	3.6 Amp	

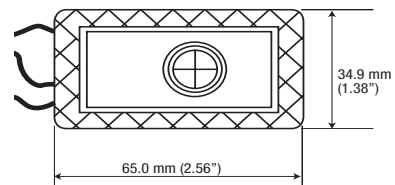
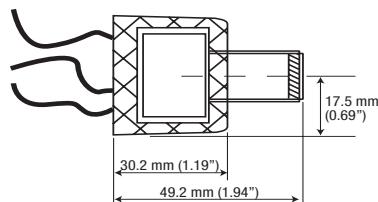
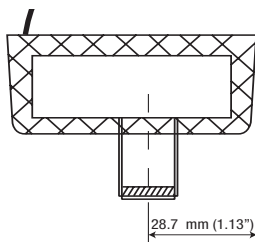

# Mercmaster™ III 400 Luminaire for Hazardous and Wet Locations

## 400 W PSMH

\* Photometric data is based on a fixture with a 400-watt clear Pulse Start Metal Halide lamp (44,000 lumen). For candlepower values of fixtures with other PSMH lamps, use the following multipliers: for a 320 W (33,000 lumen) PSMH lamp – .750; for a 350 W (37,000 lumen) PSMH lamp – .840. For candlepower values of fixture with guard, multiply by – 0.95.

**NEC/CEC:**

Class I, Division 2, Groups A, B, C, D  
 Class I, Zone 2, AEx nA nR IIC (Z2)  
 Class I, Zone 2, AEx/Ex nR IIC (ZB)  
 Class II, Division 1 and 2, Groups E, F, G  
 Class III

**NEC/CEC:**

Simultaneous Exposure (Class I, Division 2/  
 Class II, Division 1)  
 Fixtures Outside Type (Salt Water)  
 Type 4X  
 IP66

**Photometric Data**

**Zone Lumens TOTAL LUMINAIRE EFFICIENCY = 92.6%**

Zone	Lumens	CIE Type – General Diffuse		
0-10	118.85			
10-20	488.36			
20-30	948.99			
30-40	1678.84			
40-50	2714.15			
50-60	3299.55			
60-70	3919.47			
70-80	4497.45			
80-90	4892.41			
90-100	4803.79			
100-110	4404.56			
110-120	3849.71			
120-130	3078.18			
130-140	1852.83			
140-150	185.86			
150-160	14.88			
160-170	1.78			
170-180	0.12			

ZONAL LUMEN SUMMARY			
Zone	Lumens	% Lamp	% Fixture
0-30	1556.19	3.5	3.8
0-40	3235.03	7.4	7.9
0-60	9248.74	21.0	22.7
0-90	22558.07	51.3	55.4
90-120	13058.07	29.7	32.0
90-130	16136.25	36.7	39.6
90-150	18174.93	41.3	44.6
90-180	18191.71	41.3	44.6
0-180	40749.78	92.6	100.0

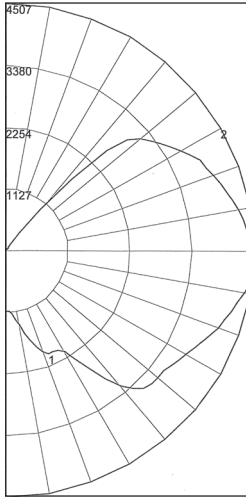

REPORT NUMBER: **KP40PG**

Lamps: 400 W Pulse Start Metal Halide with Globe \*

**Coefficients of Utilization – Zonal Cavity Method**

Effective Floor Cavity Reflectance 0.20

% Ceiling	Rcc	80			70			50			30			10			0		
		70	50	30	10	70	50	30	10	50	30	10	50	30	10				
% Walls	Rw	70	50	30	10	70	50	30	10	50	30	10	50	30	10	50	30	10	0
0	100	100	100	100	100	93	93	93	93	80	80	80	68	68	68	57	57	57	51
1	86	80	74	69	69	79	73	68	64	62	58	54	51	48	45	41	39	37	32
2	76	67	59	52	52	70	61	54	48	51	45	41	42	37	33	33	30	27	22
3	68	57	48	41	41	62	52	44	38	45	37	32	35	30	26	28	24	20	16
4	62	49	40	33	33	56	45	37	30	37	31	26	30	25	21	24	20	16	13
5	56	43	34	27	27	51	40	31	25	33	26	21	27	21	17	21	17	13	10
6	51	38	29	23	23	47	35	27	21	29	23	18	24	18	14	18	14	11	8
7	47	34	25	20	20	43	31	24	18	26	20	15	21	16	12	17	12	9	7
8	44	31	22	17	17	40	28	21	16	24	17	13	19	14	10	15	11	8	6
9	41	28	20	15	15	37	26	18	14	21	15	11	18	13	9	14	10	7	5
10	38	25	18	13	13	35	23	16	12	20	14	10	16	11	8	13	9	6	4

**Zone Lumens TOTAL LUMINAIRE EFFICIENCY = 81.4%**

Zone	Lumens	CIE Type – Direct		
0-10	561.93			
10-20	1748.92			
20-30	2859.54			
30-40	4018.21			
40-50	5254.58			
50-60	5772.38			
60-70	6052.84			
70-80	5887.04			
80-90	3512.71			
90-100	137.17			
100-110	0.00			
110-120	0.00			
120-130	0.00			
130-140	0.00			
140-150	0.00			
150-160	0.00			
160-170	0.00			
170-180	0.00			

Plane	Spacing Criteria
0-180	1.76
90-270	1.76
Diagonal	1.86

ZONAL LUMEN SUMMARY			
Zone	Lumens	% Lamp	% Fixture
0-30	5170.39	11.8	14.4
0-40	9188.60	20.9	25.7
0-60	20215.55	45.9	56.5
0-90	35668.14	81.1	99.6
90-120	137.17	0.3	0.4
90-130	137.17	0.3	0.4
90-150	137.17	0.3	0.4
90-180	137.17	0.3	0.4
0-180	35805.32	81.4	100.0

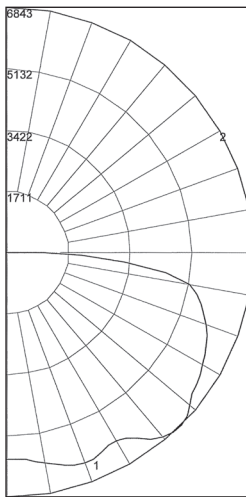

REPORT NUMBER: **KP40PST**

Lamps: 400 W Pulse Start Metal Halide with Standard Dome Reflector \*

**Coefficients of Utilization – Zonal Cavity Method**

Effective Floor Cavity Reflectance 0.20

% Ceiling	Rcc	80			70			50			30			10			0		
		70	50	30	10	70	50	30	10	50	30	10	50	30	10				
% Walls	Rw	70	50	30	10	70	50	30	10	50	30	10	50	30	10	50	30	10	0
0	97	97	97	97	97	95	95	95	95	90	90	90	86	86	86	83	83	83	81
1	84	78	73	68	68	81	76	71	67	72	69	65	69	66	63	66	63	61	59
2	74	65	58	51	51	72	63	57	51	60	54	49	57	52	48	55	51	47	45
3	66	55	47	40	40	64	54	46	40	51	44	39	49	43	38	46	42	37	35
4	60	48	39	32	32	58	47	39	32	44	37	32	42	36	31	40	35	31	28
5	55	42	33	27	27	53	41	33	27	39	32	26	37	31	26	36	30	26	24
6	50	37	29	23	23	48	36	28	23	35	28	22	33	27	22	32	26	22	20
7	46	33	25	20	20	44	33	25	19	31	24	19	30	24	19	29	23	19	17
8	43	30	22	17	17	41	30	22	17	28	22	17	27	21	17	26	21	17	15
9	40	28	20	15	15	38	27	20	15	26	19	15	25	19	15	24	19	15	13
10	37	25	18	13	13	36	25	18	13	24	18	13	23	17	13	22	17	13	12

# Mercmaster™ III 400 Luminaire for Hazardous and Wet Locations

## 400 W PSMH

\* Photometric data is based on a fixture with a 400-watt clear Pulse Start Metal Halide lamp (44,000 lumen). For candlepower values of fixtures with other PSMH lamps, use the following multipliers: for a 320 W (33,000 lumen) PSMH lamp – .750; for a 350 W (37,000 lumen) PSMH lamp – .840. For candlepower values of fixture with guard, multiply by – 0.95.

**NEC/CEC:**

Class I, Division 2, Groups A, B, C, D  
 Class I, Zone 2, AEx nA nR IIC (Z2)  
 Class I, Zone 2, AEx/Ex nR IIC (ZB)  
 Class II, Division 1 and 2, Groups E, F, G  
 Class III

**NEC/CEC:**

Simultaneous Exposure (Class I, Division 2/  
 Class II, Division 1)  
 Fixtures Outside Type (Salt Water)  
 Type 4X  
 IP66

**Photometric Data**

TOTAL LUMINAIRE EFFICIENCY = 76%

Zone	Lumens	Plane	Spacing Criteria
0-10	499.96		
10-20	1605.38		
20-30	2680.72		
30-40	3841.49	0-180	2.28
40-50	4899.23	90-270	1.92
50-60	4819.21	Diagonal	1.84
60-70	4564.58		
70-80	4063.65		
80-90	3258.13		

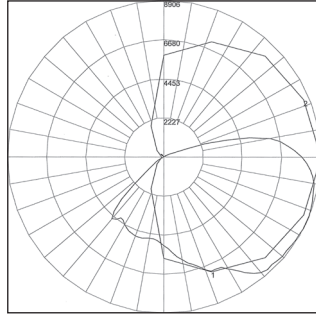

REPORT NUMBER: **KP40PAN**

Lamps: 400 W Pulse Start Metal Halide with  
 30° Angle Dome Reflector \*

**Coefficients of Utilization – Zonal Cavity Method**

Effective Floor Cavity Reflectance 0.20

% Ceiling	Rcc	80				70				50				30				10				0
		70	50	30	10	70	50	30	10	50	30	10	50	30	10	50	30	10				
0	89	89	89	89	86	86	86	86	80	80	80	75	75	75	71	71	71	69				
1	78	72	68	64	75	70	66	62	65	62	59	61	58	56	57	55	53	50				
2	69	61	55	49	66	59	53	48	55	50	46	51	47	43	48	44	41	39				
3	62	52	45	39	59	51	44	38	47	41	37	44	39	35	41	37	33	31				
4	56	46	38	32	54	44	37	31	41	35	30	38	33	29	36	31	28	26				
5	51	40	33	27	49	39	32	26	36	30	25	34	29	24	32	27	23	21				
6	47	36	28	23	45	35	28	22	32	26	22	30	25	21	29	24	20	18				
7	43	32	25	20	42	31	24	19	29	23	19	27	22	18	26	21	17	16				
8	40	29	22	17	39	28	22	17	27	21	16	25	20	16	24	19	15	14				
9	37	26	20	15	36	26	19	15	24	19	15	23	18	14	22	17	14	12				
10	35	24	18	14	34	24	17	13	22	17	13	21	16	13	20	15	12	11				

APPLETON™

HID/AREA: NEC/CEC ENCLOSED AND GASKETED

**ZONAL LUMEN SUMMARY**

Zone	Lumens	% Lamp	% Fixture
100-110	762.24		
110-120	138.12	0-30	4786.06 10.9 14.3
120-130	77.59	0-40	8627.55 19.6 25.8
130-140	73.07	0-60	18345.99 41.7 54.9
140-150	25.07	0-90	30232.35 68.7 90.4
150-160	10.91	90-120	3005.49 6.8 9.0
160-170	5.30	90-130	3083.09 7.0 9.2
170-180	1.45	90-150	3181.23 7.2 9.5
		90-180	3198.89 7.3 9.6
		0-180	33431.25 76.0 100.0

# Mercmaster™ III 400 Luminaire for Hazardous and Wet Locations

## 400 W PSMH

\* Photometric data is based on a fixture with a 400-watt clear Pulse Start Metal Halide lamp (44,000 lumen). For candlepower values of fixtures with other PSMH lamps, use the following multipliers: for a 320 W (33,000 lumen) PSMH lamp – .750; for a 350 W (37,000 lumen) PSMH lamp – .840. For candlepower values of fixture with guard, multiply by – 0.95.

**NEC/CEC:**  
 Class I, Division 2, Groups A, B, C, D  
 Class I, Zone 2, AEx nA nR IIC (Z2)  
 Class I, Zone 2, AEx/Ex nR IIC (ZB)  
 Class II, Division 1 and 2, Groups E, F, G  
 Class III

**NEC/CEC:**  
 Simultaneous Exposure (Class I, Division 2)  
 Class II, Division 1)  
 Fixtures Outside Type (Salt Water)  
 Type 4X  
 IP66

### Photometric Data

Zone	Lumens	TOTAL LUMINAIRE EFFICIENCY = 78.4%		
0-10	77.24	<b>CIE Type – Semi-Direct</b>		
10-20	575.14	<b>Plane</b>	<b>Spacing Criteria</b>	
20-30	1061.45			
30-40	1581.40	0-180	1.36	
40-50	4468.52	90-270	1.40	
50-60	4938.88	Diagonal	2.42	
60-70	6338.26			
70-80	5875.90	<b>ZONAL LUMEN SUMMARY</b>		
80-90	3886.90	<b>Zone</b>	<b>Lumens</b>	<b>% Lamp % Fixture</b>
90-100	1318.17	0-30	1713.83	3.9 5.0
100-110	1872.98	0-40	3295.23	7.5 9.6
110-120	1122.17	0-60	12702.64	28.9 36.8
120-130	616.83	0-90	28803.69	65.5 83.5
130-140	358.56	90-120	4313.33	9.8 12.5
140-150	224.03	90-130	4930.15	11.2 14.3
150-160	128.38	90-150	5512.75	12.5 16.0
160-170	50.79	90-180	5699.61	13.0 16.5
170-180	7.69	0-180	34503.3	78.4 100.0

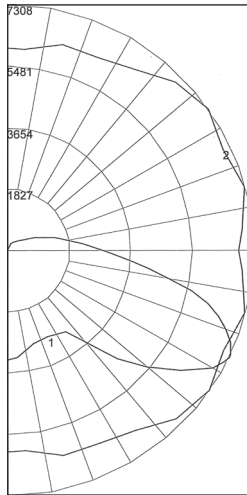

REPORT NUMBER: **KP40PJ5**

Lamps: 400 W Pulse Start Metal Halide with  
 8" Prismatic Glass Refractor – NEMA Type V \*

**Coefficients of Utilization – Zonal Cavity Method**

**Effective Floor Cavity Reflectance 0.20**

% Floors Rfc	% Ceiling Rcc	% Walls Rw	20															
			80			70			50			30			10			0
0	90	90	90	90	87	87	87	87	80	80	80	74	74	74	68	68	68	65
1	77	71	66	61	73	68	63	59	62	58	54	57	53	50	52	49	47	44
2	67	58	50	44	64	55	48	42	50	44	39	45	41	37	41	37	34	31
3	59	48	40	33	56	46	38	32	42	35	30	38	32	27	34	29	25	23
4	53	41	33	26	50	39	31	25	35	29	23	32	26	21	29	24	20	17
5	48	36	27	21	45	34	26	20	31	24	18	28	22	17	25	20	16	13
6	44	31	23	17	41	30	22	16	27	20	15	24	18	14	22	17	13	11
7	40	28	20	14	38	26	19	14	24	17	13	22	16	12	19	14	11	9
8	37	25	17	12	35	24	17	11	22	15	11	19	14	10	18	13	9	7
9	34	22	15	10	32	21	15	10	20	13	9	18	12	8	16	11	8	6
10	32	20	14	9	30	20	13	9	18	12	8	16	11	7	15	10	7	5

Zone	Lumens	TOTAL LUMINAIRE EFFICIENCY = 64.2%		
0-10	514.26	<b>CIE Type – Direct</b>		
10-20	1734.49	<b>Plane</b>	<b>Spacing Criteria</b>	
20-30	3370.99			
30-40	5333.06	0-180	2.32	
40-50	7165.13	90-270	2.32	
50-60	6195.93	Diagonal	2.04	
60-70	2879.28			
70-80	921.95	<b>ZONAL LUMEN SUMMARY</b>		
80-90	111.28	<b>Zone</b>	<b>Lumens</b>	<b>% Lamp % Fixture</b>
90-100	0.14	0-30	5619.74	12.8 19.9
100-110	0.00	0-40	10952.81	24.9 38.8
110-120	0.00	0-60	24313.86	55.3 86.1
120-130	0.00	0-90	28226.37	64.2 100.0
130-140	0.00	90-120	0.14	0.0 0.0
140-150	0.00	90-130	0.14	0.0 0.0
150-160	0.00	90-150	0.14	0.0 0.0
160-170	0.00	90-180	0.14	0.0 0.0
170-180	0.00	0-180	28226.50	64.2 100.0

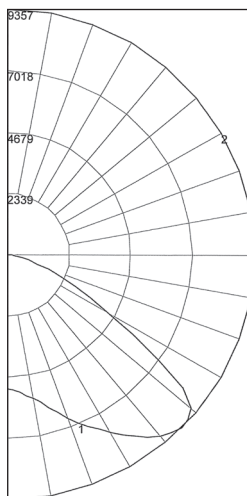

REPORT NUMBER: **KP40PHB**

Lamps: 400 W Pulse Start Metal Halide with  
 Enclosed Reflector (**KPR-4HB**) \*

**Coefficients of Utilization – Zonal Cavity Method**

**Effective Floor Cavity Reflectance 0.20**

% Floors Rfc	% Ceiling Rcc	% Walls Rw	20															
			80			70			50			30			10			0
0	76	76	76	76	75	75	75	75	71	71	71	68	68	68	65	65	65	64
1	70	67	65	63	69	66	64	62	63	61	60	61	59	58	59	57	56	55
2	64	59	55	51	62	58	54	50	55	52	49	53	51	48	51	49	47	46
3	58	51	46	42	56	50	46	42	48	44	41	47	43	40	45	42	40	38
4	53	45	39	35	51	44	39	35	43	38	34	41	37	34	40	36	33	32
5	48	40	34	30	47	39	34	29	38	33	29	36	32	29	35	31	28	27
6	44	35	29	25	43	35	29	25	34	29	25	32	28	25	31	28	24	23
7	41	32	26	22	39	31	26	22	30	25	22	29	25	21	28	24	21	20
8	37	29	23	19	36	28	23	19	27	22	19	26	22	19	26	22	19	17
9	35	26	20	17	34	25	20	17	25	20	17	24	20	16	23	19	16	15
10	32	24	18	15	32	23	18	15	23	18	15	22	18	15	21	17	15	13